

16A Non-Isolated, SMT DC/DC Converter with wide trim

The NiQor™ SMT DC/DC converter is a non-isolated buck regulator, which employs synchronous rectification to achieve extremely high conversion efficiency. The NiQor family of converters are used predominately in DPA systems using a front end DC/DC high power brick (48V_{in} to low voltage bus). The non-isolated NiQor converters are then used at the point of load to create the low voltage outputs required by the design. The wide trim module can be programmed to a variety of output voltages through the use of a single external resistor.



NQ12T50SMA16 wide trim module

Operational Features

- Ultra-high efficiency, up to 95% at full and half load
- Delivers 16 amps of output current with minimal derating - no heatsink required
- Input voltage range: 9.6 - 14.4V
- Programmable output voltages from 0.85 - 5.0V
- On-board input and output filter capacitor
- No minimum load requirement means no preload resistors required

Protection Features

- Input under-voltage lockout disables converter at low input voltage conditions
- Temperature compensated over-current shutdown protects converter from excessive load current or short circuits
- Output over-voltage protection protects load from damaging voltages
- Thermal shutdown

Mechanical Features

- Industry standard SMT pin-out configuration
- Industry standard size: 1.3" x 0.53" x 0.29" (33 x 13.5 x 7.3 mm)
- Total weight: 0.18 oz. (5 grams), lower mass greatly reduces vibration and shock problems
- Open frame construction maximizes air flow cooling
- Also available in SIP packaging

Control Features

- On/Off control
- Remote sense
- Output voltage trim (industry standard) permits custom voltages and voltage margining
- Fixed output voltage modules available (0.9 - 5.0V)

Safety Features

- UL 1950 recognized (US & Canada)
- TUV certified to EN60950
- Meets 72/23/EEC and 93/68/EEC directives which facilitates CE Marking in user's end product
- Board and plastic components meet UL94V-0 flammability requirements

MECHANICAL DIAGRAM

Surface Mount Package

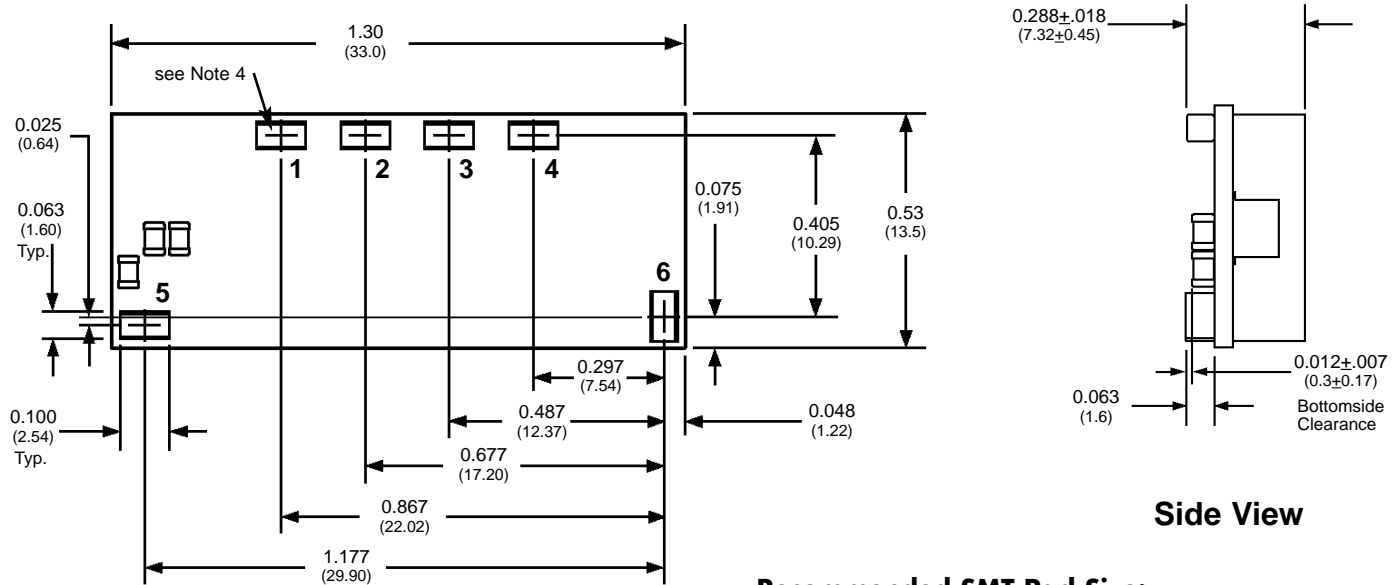

Recommended SMT Pad Size:

Minimum: 0.074" x 0.122" (1.88mm x 3.1mm)

Maximum: 0.095" x 0.140" (2.41mm x 3.56mm)

NOTES

- 1) SMT Contacts: Material - Brass
Finish - Gold over Nickel plate
- 2) Undimensioned components are shown for visual reference only.
- 3) All dimensions in inches (mm)
Tolerances: x.xx +/-0.02 in. (x.x +/-0.5mm)
x.xxx +/-0.010 in. (x.xx +/-0.25mm)
- 4) Coplanarity for pins 1-6 is 0.004" max
- 5) Weight: 0.18 oz. (5 g) typical
- 6) Vertical and horizontal SIP pin options also available.
- 7) Workmanship: Meets or exceeds IPC-A-610C Class II

SMT CONTACT DESIGNATIONS

Pin No.	Name	Function
1	GND	Ground
2	Vout(+)	Positive output voltage
3	TRIM	Output Voltage Trim
4	SENSE(+)	Positive remote sense
5	Vin(+)	Positive input voltage
6	ON/OFF	Input to turn converter on/off

ELECTRICAL CHARACTERISTICS - NQ12T50SMA16 Series

T_A=25°C, airflow rate=300 LFM, V_{in}=12Vdc unless otherwise noted; full operating temperature range is -40°C to +105°C ambient temperature with appropriate power derating. Specifications subject to change without notice.

Parameter	Module	Min.	Typ.	Max.	Units	Notes & Conditions
ABSOLUTE MAXIMUM RATINGS						
Input Voltage						
Non-Operating	All	0		16	V	continuous
Operating	All			14.4	V	continuous
Operating Temperature	All	-40		105	°C	
Storage Temperature	All	-55		125	°C	
Voltage at ON/OFF input pin	All	-3		15	V	
INPUT CHARACTERISTICS						
Operating Input Voltage Range	All	9.6	12	14.4	V	
Input Under-Voltage Lockout						
Turn-On Voltage Threshold	All	8.25	8.75	9.2	V	
Turn-Off Voltage Threshold	All	7.25	7.75	8.1	V	
Lockout Hysteresis	All		1.0		V	
Maximum Input Current	0.9V 1.2V 1.5V 1.8V 2.5V 3.3V 5.0V			2.25 3.0 3.5 4.0 5.5 7.0 10.5	A A A A A A A	9.6V _{in} , 100% Load, 10% trim up (all)
No-Load Input Current	0.9V 1.2V 1.5V 1.8V 2.5V 3.3V 5.0V		0.026 0.031 0.037 0.043 0.062 0.084 0.116	0.031 0.037 0.045 0.052 0.075 0.101 0.140	A A A A A A A	
Disabled Input Current	All		4	10	mA	
Inrush Current Transient Rating	All			0.1	A ² s	with min. output capacitance
Response to Input Transient	0.9-2.5V 3.3V 5.0V		5 7.5 12.5		mV/V mV/V mV/V	80V/ms input transient (all)
Input Reflected-Ripple Current	0.9V 1.2V 1.5V 1.8V 2.5V 3.3V 5.0V		40 52 64 75 97 117 145	73 95 114 133 168 197 220	mA mA mA mA mA mA mA	pk-pk thru 1µH inductor; Fig 15-16 (all)
Recommended Input Fuse	All			15	A	fast blow external fuse recommended
Input Filter Capacitor Value	All		30		µF	internal ceramic
Input Ripple Voltage	0.9V 1.2V 1.5V 1.8V 2.5V 3.3V 5.0V		51 66 80 92 116 137 160		mV mV mV mV mV mV mV	RMS, full load, Figures 15, 17 (all)

ELECTRICAL CHARACTERISTICS (continued) - NQ12T50SMA16 Series

Parameter	Module	Min.	Typ.	Max.	Units	Notes & Conditions	
OUTPUT CHARACTERISTICS							
Output Voltage Set Point	0.9V	0.888	0.900	0.912	V	12V _{in} ; 50% load (all)	
	1.2V	1.184	1.200	1.216	V		
	1.5V	1.481	1.500	1.520	V		
	1.8V	1.777	1.800	1.823	V		
	2.5V	2.468	2.500	2.533	V		
	3.3V	3.257	3.300	3.343	V		
	5.0V	4.935	5.000	5.065	V		
Output Voltage Regulation	Over Line	All	TBD	3	mV	with sense pin	
	Over Load	All	TBD	7	mV		
	Over Temperature	All	±0.50	±1.50	%		
Total Output Voltage Range	0.9V	0.882		0.918	V	with sense pin, over sample, line, load, temperature & life (all)	
	1.2V	1.176		1.224	V		
	1.5V	1.470		1.530	V		
	1.8V	1.764		1.836	V		
	2.5V	2.450		2.550	V		
	3.3V	3.234		3.366	V		
	5.0V	4.900		5.100	V		
Output Voltage Ripple and Noise (pk-pk\RMS)	0.9-2.5V		25\10	40\12	mV	Full load; 20MHz bandwidth; Figs 15, 18	
	3.3V		30\10	50\17	mV		
	5.0V		35\10	60\20	mV		
Operating Output Current Range	All	0		16	A		
Output DC Over-Current Shutdown	All	17	22	27	A	Figure 23	
Output Capacitance Range	All	100		5,000	µF	>2.5 mΩ ESR	
DYNAMIC CHARACTERISTICS							
Input Voltage Ripple Rejection	0.9V		90		dB	120 Hz; Figure 20	
	5.0V		65		dB		
Output Voltage during Load Current Transient	For a Step Change in Output Current (0.1A/µs)	All	40	75	mV	50%-75%-50% I _{out} max, 100µF, Fig 13 50%-75%-50% I _{out} max, 470µF, Fig 14 to within 1.5% V _{out} nom., Figs 13-14	
	For a Step Change in Output Current (3A/µs)	All	100		mV		
	Settling Time	All	50				µs
Turn-On Transient	Turn-On Time	0.9-1.5V	0.75	1.5	2.5	ms	Figures 11-12 Full resistive load, V _{out} =100% nom. (all)
	Output Voltage Overshoot	1.8-5.0V	1	2	3	ms	resistive load
	All		0	1	%		
EFFICIENCY							
100% Load	0.9V		83		%	Figures 1-4	
	1.2V		86		%		
	1.5V		88		%		
	1.8V		89		%		
	2.5V		92		%		
	3.3V		93		%		
	5.0V		94		%		
50% Load	0.9V		87		%	Figures 1-4	
	1.2V		89		%		
	1.5V		91		%		
	1.8V		91		%		
	2.5V		93		%		
	3.3V		94		%		
	5.0V		95		%		
TEMP. LIMITS FOR POWER DERATING							
Semiconductor Junction Temperature	All			125	°C	Package rated to 150°C; Figs 5-10	
Board Temperature	All			125	°C	UL rated max operating temp 130°C	



Technical Specification

**Non-Isolated
SMT Converter** **9.6 - 14.4V_{in} 16A**

ELECTRICAL CHARACTERISTICS (continued) - NQ12T50SMA16 Series

Parameter	Module	Min.	Typ.	Max.	Units	Notes & Conditions
FEATURE CHARACTERISTICS						
Switching Frequency	All	300	325	350	kHz	may drop by 10% at light load
ON/OFF Control						See Applications Information
Off-State Voltage	All			2.3	V	
On-State Voltage	All	2.65			V	
Pull-Up Voltage	All		V _{in} /2		V	
Pull-Up Resistance	All		10		kΩ	
Output Voltage Trim Range	All	-10		+10	%	Measured V _{out} + to common pins; Table 1
Output Voltage Remote Sense Range	All			+10	%	Measured V _{out} + to common pins
Output Over-Voltage Protection	0.9V	140	145	150	%	Over full temp range; % of nominal V _{out}
	1.2-5.0V	118	127	140	%	
Over-Temperature Shutdown	All		133		°C	Average PCB Temperature
Over-Temperature Shutdown Restart Hysteresis	All		12		°C	
RELIABILITY CHARACTERISTICS						
Calculated MTBF (Telcordia)	All		TBD		10 ⁶ Hrs.	TR-NWT-000332; 100% load, 200LFM, 40°C T _a
Calculated MTBF (MIL-217)	All		TBD		10 ⁶ Hrs.	MIL-HDBK-217F; 100% load, 200LFM, 40°C T _a
Field Demonstrated MTBF	All				10 ⁶ Hrs.	See website for latest values

STANDARDS COMPLIANCE

Parameter	Notes
STANDARDS COMPLIANCE	
UL/cUL 60950	File # E194341
EN60950	Certified by TÜV
72/23/EEC	
93/68/EEC	
Needle Flame Test (IEC 695-2-2)	test on entire assembly; board & plastic components UL94V-0 compliant
IEC 61000-4-2	ESD test, 8kV - NP, 15kV air - NP (Normal Performance)
GR-1089-CORE	Section 7 - electrical safety, Section 9 - bonding/grounding
Telcordia (Bellcore) GR-513	

- An external input fuse must always be used to meet these safety requirements. Contact SynQor for official safety certificates on new releases or download from the SynQor website.

QUALIFICATION TESTING

Parameter	# Units	Test Conditions
QUALIFICATION TESTING		
Life Test	32	95% rated V _{in} and load, units at derating point, 1000 hours
Vibration	5	10-55Hz sweep, 0.060" total excursion, 1 min./sweep, 120 sweeps for 3 axis
Mechanical Shock	5	100g minimum, 2 drops in x and y axis, 1 drop in z axis
Temperature Cycling	10	-40°C to 100°C, unit temp. ramp 15°C/min., 500 cycles
Power/Thermal Cycling	5	Toperating = min to max, V _{in} = min to max, full load, 100 cycles
Design Marginality	5	T _{min} -10°C to T _{max} +10°C, 5°C steps, V _{in} = min to max, 0-105% load
Humidity	5	85°C, 85% RH, 1000 hours, continuous V _{in} applied except 5min./day
Solderability	15 pins	MIL-STD-883, method 2003

- Extensive characterization testing of all SynQor products and manufacturing processes is performed to ensure that we supply robust, reliable product. Contact factory for official product family qualification document.

OPTIONS

SynQor provides various options for Packaging, Enable Logic, and Feature Set for this family of DC/DC converters. Please consult the last page of this specification sheet for information on available options.

PATENTS

SynQor is protected under various patents, including but not limited to U.S. Patent numbers: 5,999,417; 6,222,742 B1; 6,594,159 B2; 6,545,890 B2.

Performance Curves

Non-Isolated SMT Converter **9.6 - 14.4V_{in} 16A**

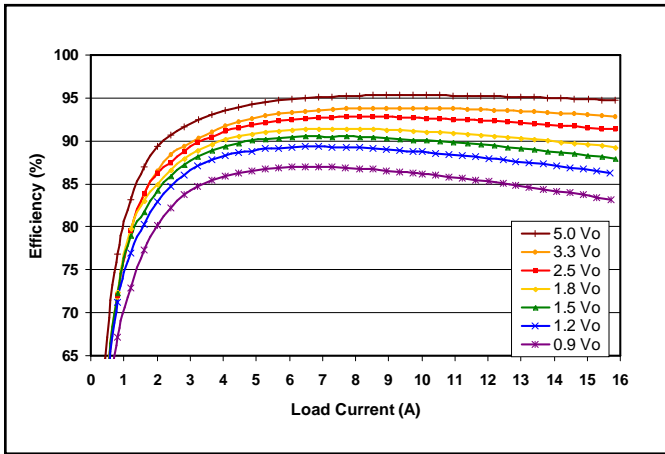

Figure 1: Efficiency at nominal output voltage vs. load current for nominal input voltage at 25°C.

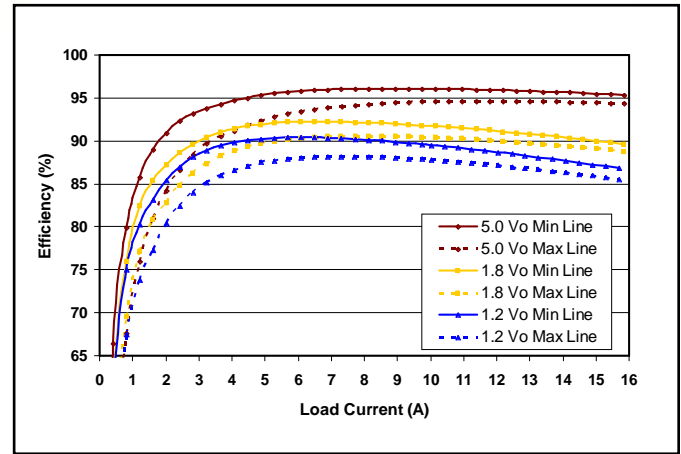

Figure 2: Efficiency at min and max line vs. load current for 1.2V, 1.8V and 5.0V units at 25°C.

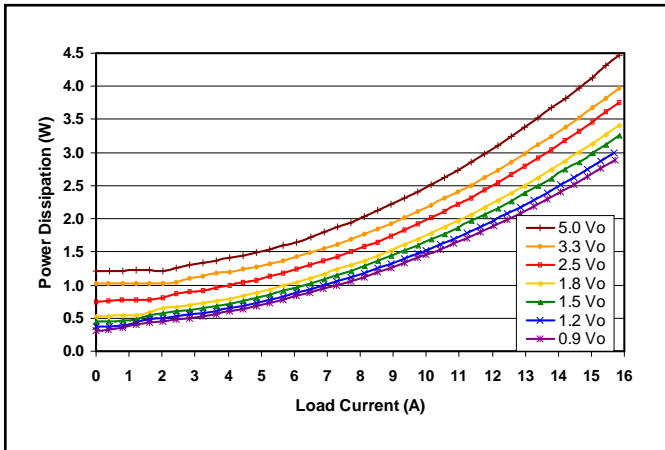

Figure 3: Power dissipation at nominal output voltage vs. load current for nominal input voltage at 25°C.

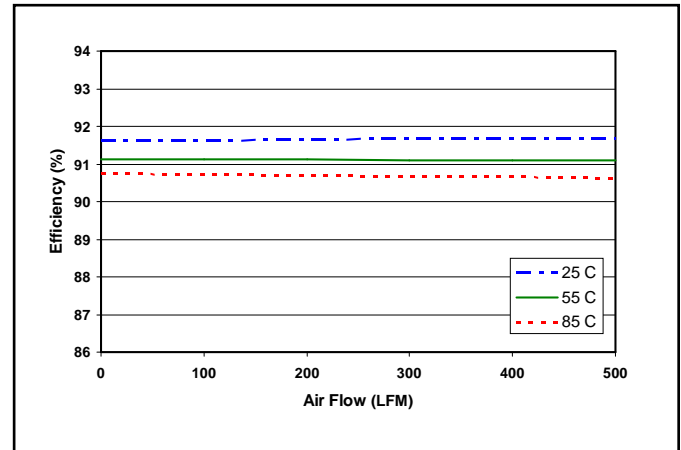

Figure 4: Efficiency at 1.8V_{out} and 60% rated power vs. airflow rate for ambient air temperatures of 25°C, 55°C, and 85°C (nominal input voltage).

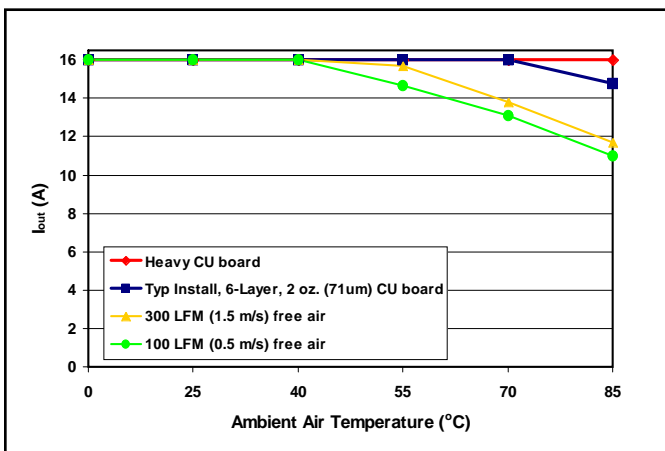

Figure 5: Maximum output power derating curves for 0.9V, 1.2V, 1.5V units under various thermal conditions and nominal input voltage. See Thermal Considerations section for more details.

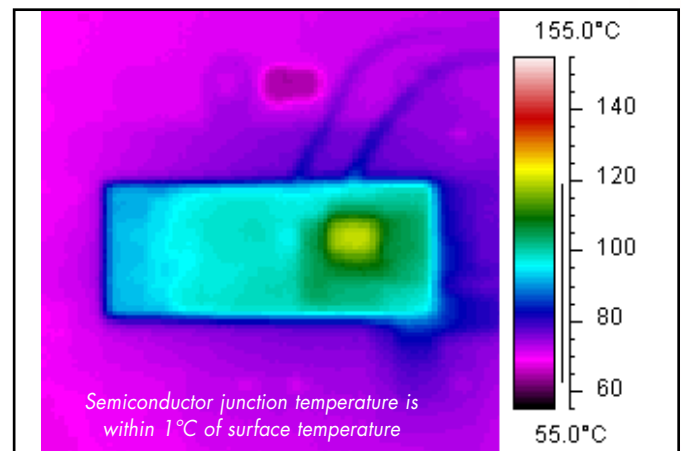

Figure 6: Thermal plot of 0.9V, 1.2V, 1.5V converters at nominal V_{in} and 16 amp load current mounted on a 70°C, 6-Layer, 2 oz. copper board (typical installation).

Performance Curves

Non-Isolated SMT Converter **9.6 - 14.4V_{in}** **16A**

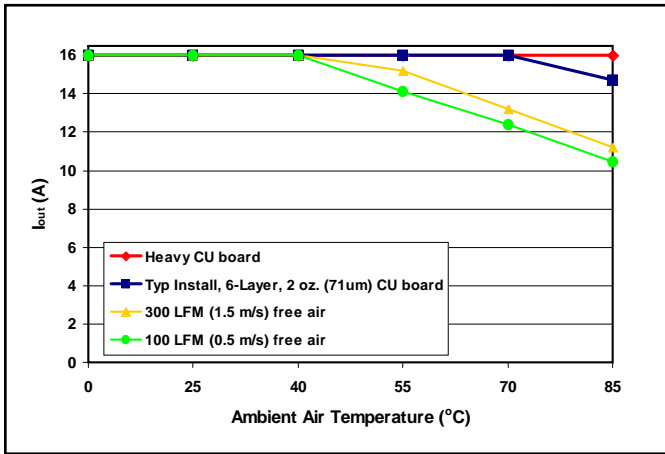

Figure 7: Maximum output power derating curves for 1.8Vo, 2.5Vo units under various thermal conditions and nominal input voltage. See Thermal Considerations section for more details.

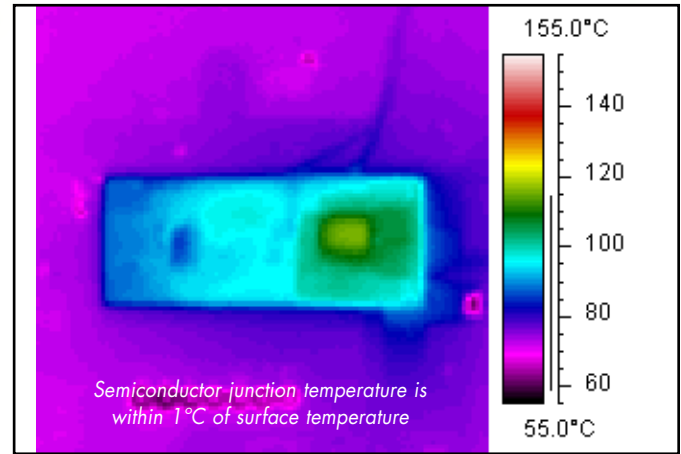

Figure 8: Thermal plot of 1.8Vo, 2.5Vo converters at nominal Vin and 16 amp load current mounted on a 70°C, 6-Layer, 2 oz. copper board (typical installation).

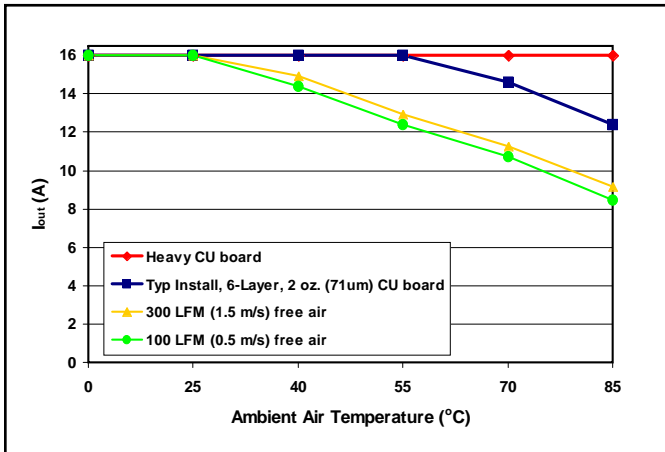

Figure 9: Maximum output power derating curves for 3.3Vo, 5.0Vo units under various thermal conditions and nominal input voltage. See Thermal Considerations section for more details.

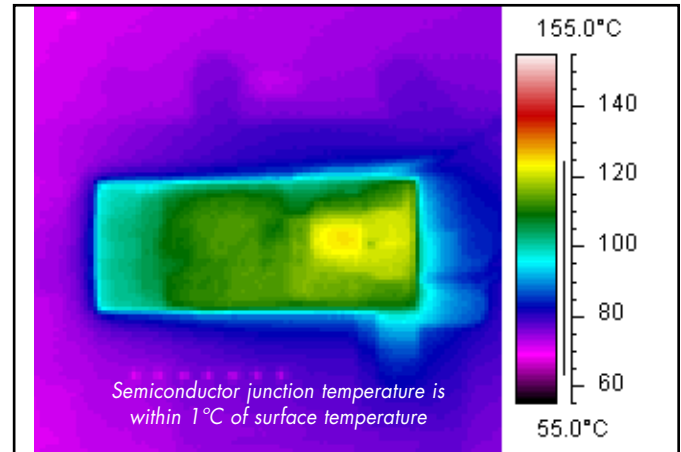

Figure 10: Thermal plot of 3.3Vo converter (16 amp load) and 5.0Vo converter (14.6 amp load). Both at nominal Vin and mounted on a 70°C, 6-Layer, 2 oz. copper board (typical installation).

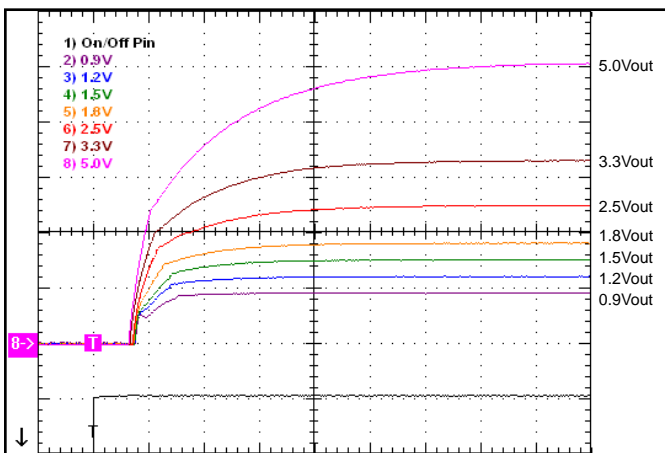

Figure 11: Turn-on transient at full load (resistive load) (400 ps/div).
Ch 1: ON/OFF input (5V/div)
Ch 2-8: Vout (1V/div)

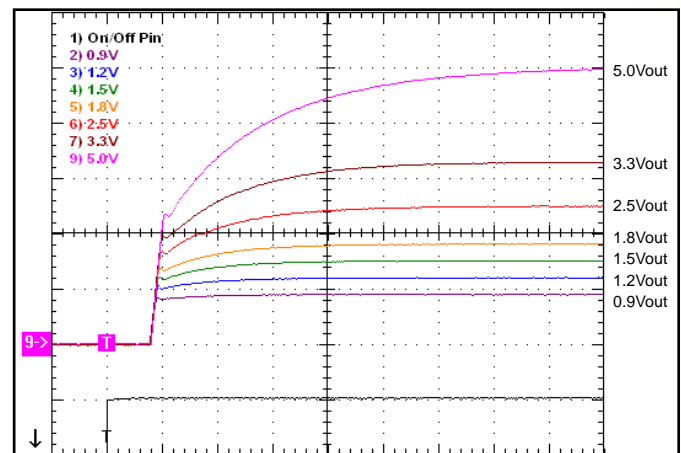

Figure 12: Turn-on transient at zero load (400 ps/div).
Ch 1: ON/OFF input (5V/div)
Ch 2-8: Vout (1V/div)

Performance Curves

Non-Isolated SMT Converter **9.6 - 14.4V_{in} 16A**

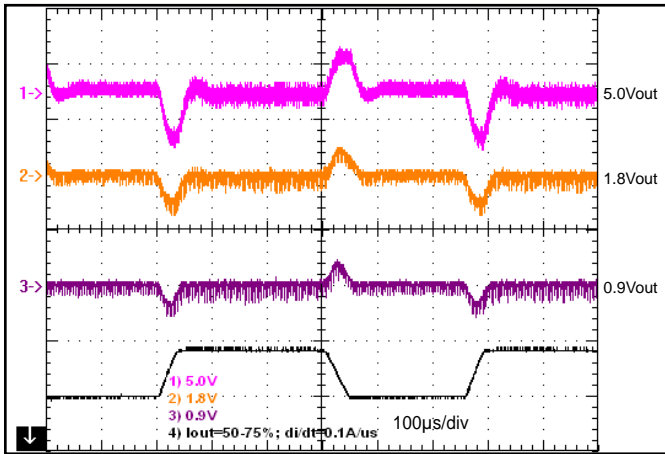

Figure 13: Output voltage response for 0.9V, 1.8V, 5.0V units to step-change in load current (50-75-50% of $I_{out\ max}$; $di/dt=0.1A/\mu s$). Load cap: 100 μF , 100m Ω ESR tant, 10 μF cer. Ch 1: I_{out} (5A/div), Ch 2-4: V_{out} (100mV/div).

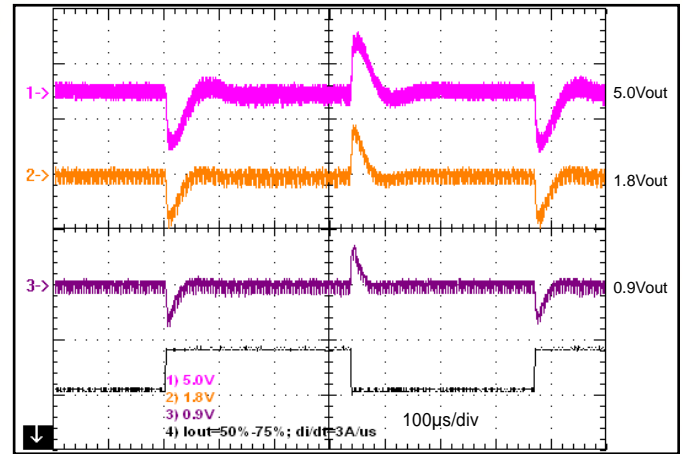

Figure 14: Output voltage response for 0.9V, 1.8V, 5.0V units to step-change in load current (50-75-50% of $I_{out\ max}$; $di/dt=3A/\mu s$). Load cap: 470 μF , 25m Ω ESR tant, 10 μF cer. Ch 1: I_{out} (5A/div), Ch 2-4: V_{out} (100mV/div).

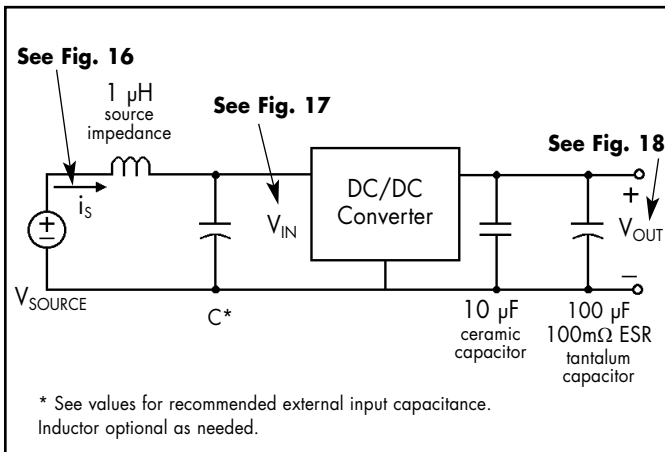

Figure 15: Test set-up diagram showing measurement points for Input Reflected Ripple Current (Figure 16), Input Terminal Ripple Voltage (Figure 17), and Output Voltage Ripple (Figure 18).

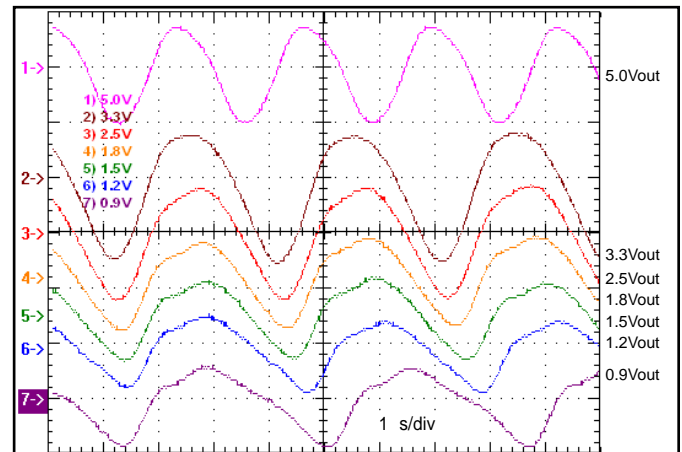

Figure 16: Input Reflected Ripple Current, I_s , through a 1 μH source inductor at nominal input voltage and rated load current (10 mA/div). See Figure 15.

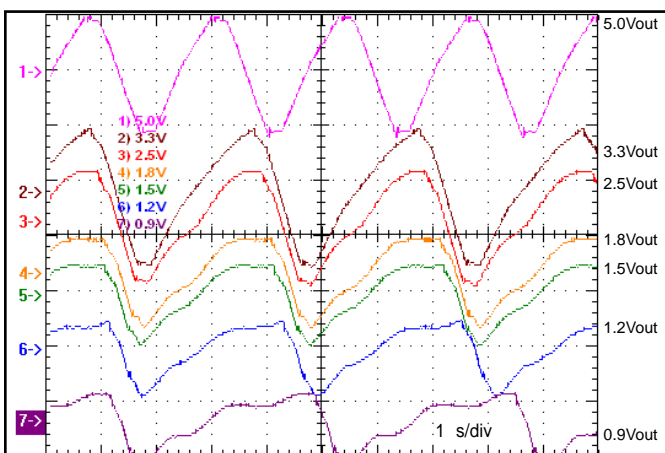

Figure 17: Input Terminal Ripple Voltage at nominal input voltage and rated load current (200 mV/div). Load capacitance: 10 μF ceramic cap and 100 μF tantalum cap. Bandwidth: 20 MHz. See Figure 15.

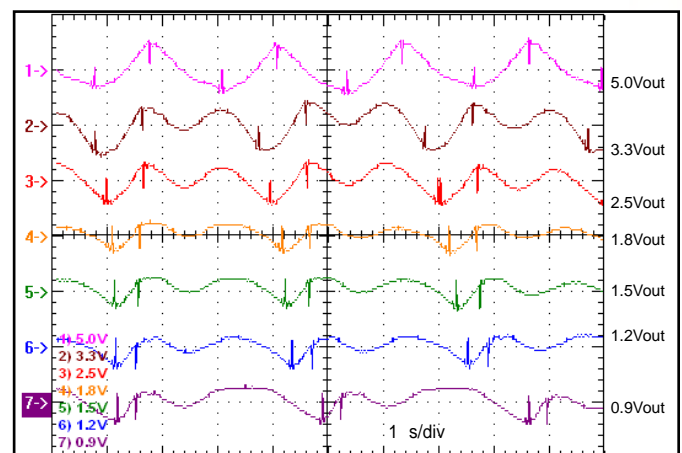

Figure 18: Output Voltage Ripple at nominal input voltage and rated load current (20 mV/div). Load capacitance: 10 μF ceramic cap and 100 μF tantalum cap.. Bandwidth: 20 MHz. See Figure 15.

Performance Curves

Non-Isolated
SMT Converter **9.6 - 14.4V_{in} 16A**

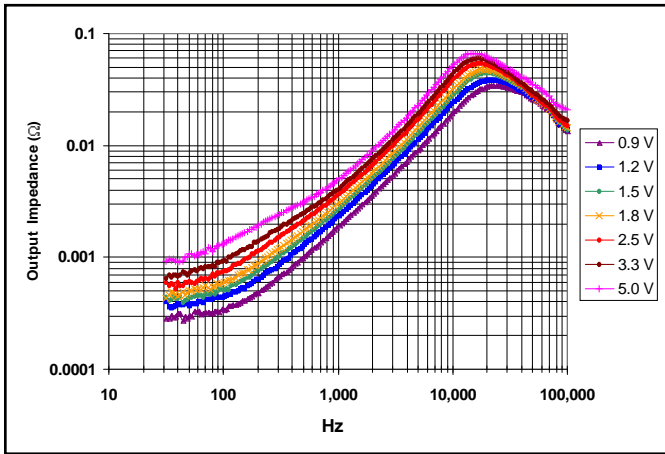

Figure 19: Magnitude of incremental output impedance ($Z_{out} = v_{out}/i_{out}$) for nominal input voltage at full rated power with 100 μ F tantalum output capacitor.

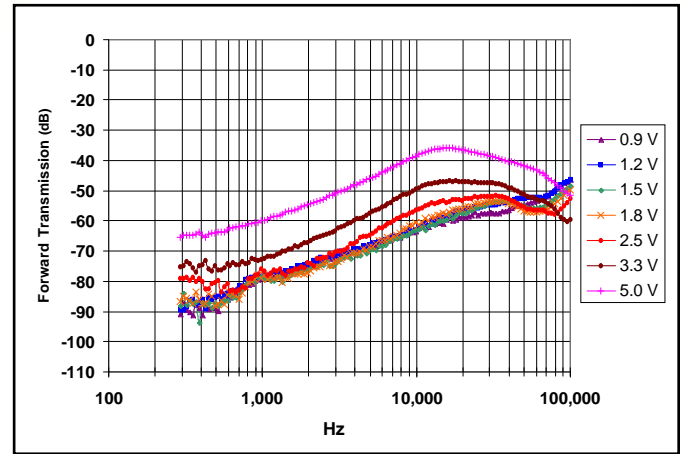

Figure 20: Magnitude of incremental forward transmission ($FT = v_{out}/v_{in}$) for nominal input voltage at full rated power with 100 μ F tantalum output capacitor.

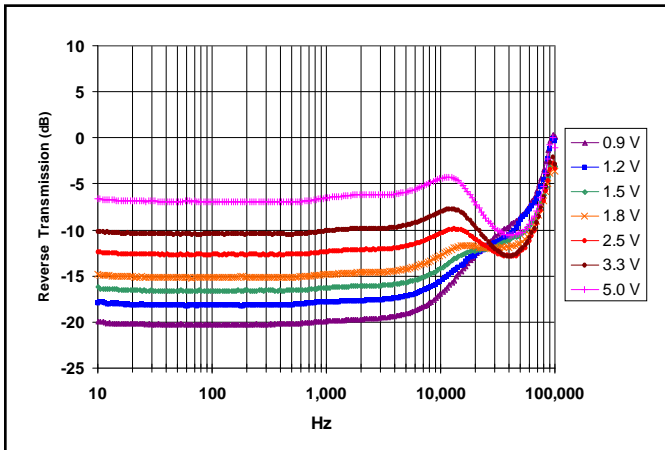

Figure 21: Magnitude of incremental reverse transmission ($RT = i_{in}/i_{out}$) for nominal input voltage at full rated power with 100 μ F tantalum output capacitor.

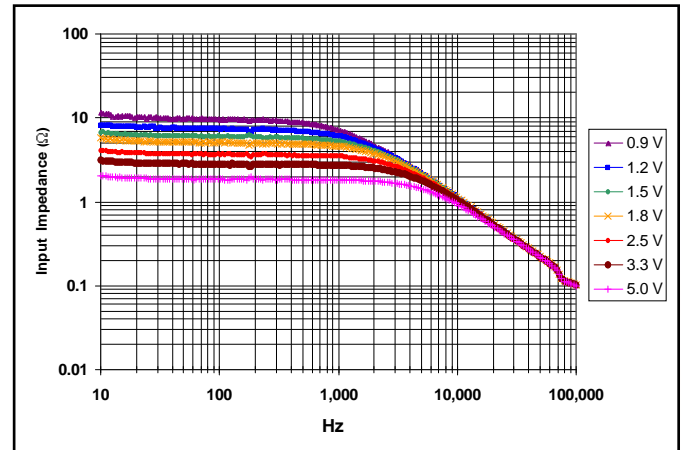

Figure 22: Magnitude of incremental input impedance ($Z_{in} = v_{in}/i_{in}$) for nominal input voltage at full rated power with 100 μ F tantalum output capacitor.

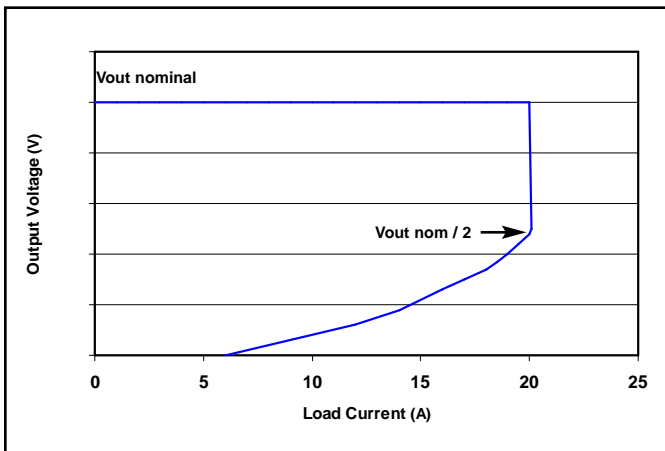

Figure 23: Output voltage vs. load current showing current limit inception point and fold-back current limit behavior.

BASIC OPERATION AND FEATURES

The NiQor series non-isolated converter uses a buck-converter that keeps the output voltage constant over variations in line, load, and temperature. The NiQor modules employ synchronous rectification for very high efficiency.

Dissipation throughout the converter is so low that it does not require a heatsink or metal baseplate for operation. The NiQor converter can thus be built more simply and reliably using high yield surface mount techniques on a single PCB substrate.

The NiQor series of SIPs and SMT converters uses the established industry standard footprint and pin-out configurations.

CONTROL FEATURES

REMOTE ON/OFF: The ON/OFF input permits the user to control when the converter is on or off. There is currently a single option available for the ON/OFF input described in the table below. Others may become available if demand exists.

Option	Description	Pin-Open Float Voltage	Pin-Open Converter State	Pin Action
P Logic	Positive/Open	V _{in} / 2	On	Pull Low = Off

OUTPUT VOLTAGE TRIM: The TRIM input permits the user to adjust the output voltage according to the trim range specifications by using an external resistor. If the TRIM feature is not being used, leave the TRIM pin disconnected.

TRIM-UP: To increase the output voltage from the nominal setpoint of 0.7525V using an external resistor, connect the resistor R_{trim-up} between the TRIM and the Ground pin according to the diagram below.

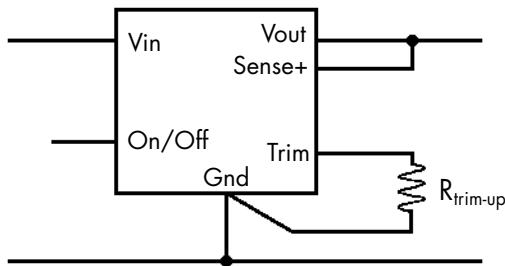

For a desired increase of the nominal output voltage, the value of the resistor should be:

$$R_{\text{trim-up}} = \frac{10500}{V_{\text{DES}} - 0.7525} - 1000 \quad (\Omega)$$

or

$$V_{\text{OUT}} = 0.7525 + \frac{10500}{R_{\text{trim-up}} + 1000} \quad (\Omega)$$

where V_{DES} = Desired Output Voltage

To maintain the accuracy of the output voltage over load current, it is vital that any trim-up resistor be terminated directly to the converter's ground foot, not at the connection to the load. A separate Kelvin connection to the PCB pad for the ground foot is optimal. Trim-down resistors should be terminated at the converter's Sense+ pin.

We do not recommend bypassing the trim pin directly to ground with a capacitor. The voltage gain from the trim pin to output is rather large, 15:1. Ground bounce through a bypass capacitor could introduce significant noise into the converter's control circuit.

PROTECTION FEATURES

Input Under-Voltage Lockout: The converter is designed to turn off when the input voltage is too low, helping avoid an input system instability problem, described in more detail in the application note titled "Input System Instability". The lockout circuitry is a comparator with DC hysteresis. When the input voltage is rising, it must exceed the typical Turn-On Voltage Threshold value (listed on the specification page) before the converter will turn on. Once the converter is on, the input voltage must fall below the typical Turn-Off Voltage Threshold value before the converter will turn off.

Output Current Limiting: The NQ12 family of converters employs foldback current limiting. A typical output voltage-current curve is shown in Figure 23 in the Performance Curves section. Current limit is reached at about 125% of rated current. Loads in excess of that limit will cause the output to droop. If the load is sufficient to pull the output down to roughly 1/2 of its nominal setpoint, foldback will ensue. From there, as the load is further increased, the output current will decrease linearly to about 1/3 of rated current at zero V_{out}. Thus, operating into a dead short, the unit will deliver 1/3 rated current indefinitely. This reduces stress on the converter and ensures that prolonged short-circuits will not overheat the converter.

Since there is no "hiccup mode" to the current-limit operation,

Technical Specification

**Non-Isolated
SMT Converter** **9.6 - 14.4V_{in} 16A**

there is also no concern with operation or startup into large capacitive loads. The voltage may rise slowly while charging the output capacitance, but it will rise.

There are also no problems starting into a load that has a resistive V-I curve. As long as the load draws less than the current limit value at 1/2 of the unit's setpoint voltage, proper startup is ensured.

Internal Over-Voltage Protection: To fully protect from excessive output voltage, the NQ12 series contains two levels of Output Over-Voltage Shutdown circuitry.

The first type monitors the output at the load via the Sense+ pin (or the output if Sense+ is left open). If the sensed voltage exceeds the (optionally trimmed) setpoint by ~10% this protective circuit asserts the converter's low-side switch until the output returns to normal. This circuit tracks the trimmed setpoint; the +10% threshold is maintained over the wide trim range of the T50 model. This circuit can also be benignly activated during the response to a large, fast drop in load current. In this instance the converter's normal transient response is momentarily overridden by this OVP. The result is a slight asymmetry in the converter's observed transient response.

It should be noted that there is no limit on this OVP; if a powerful external source attempts to raise the output of an NQ12 converter beyond 110% of its setpoint, the converter will sacrifice itself trying to draw down that external source and protect its load from the overvoltage.

The second Output Over-Voltage Shutdown circuit independently compares the voltage at the converter's output pin with that of a redundant reference. If the output ever exceeds ~125% of nominal setpoint, both converter switches are disabled. After the output voltage returns to normal, a softstart cycle is initiated.

This OVP is independent of the trimmed setpoint. As such, the converter's load is protected from faults in the external trim circuitry (such as a trim pin shorted to ground). Since the setpoint of this OVP does not track trim, it is set at 125% of 5.0V, or 6.2V, in the wide-trim T50 model.

Over-Temperature Shutdown: A temperature sensor on the converter senses the average temperature of the module. The thermal shutdown circuit is designed to turn the converter off when the temperature at the sensed location reaches the Over-Temperature Shutdown value. It will allow the converter to turn on again when the temperature of the sensed location falls by the amount of the Over-Temperature Shutdown Restart Hysteresis value.

APPLICATION CONSIDERATIONS

Input Filtering/Capacitance/Damping: The filter circuit of Figure C is often added to the converter's input to prevent switching noise from reaching the input voltage bus.

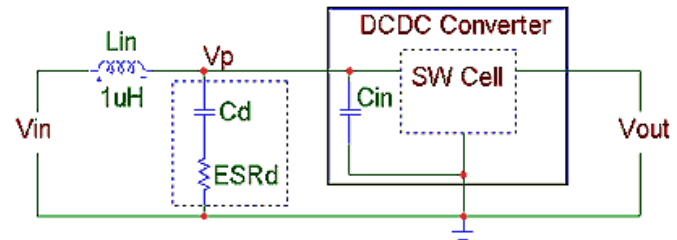

Figure C: NQ12 converter with Input Filter

In the SMA16 (surface mount) converters $C_{in} = 30\mu F$ and in the VMA16 (SIP) converters $C_{in} = 45\mu F$ of high quality ceramic capacitors. With L_{in} of $1\mu H$, C_d should be $100-200\mu F$ and R_d should be $0.1-0.2\Omega$, in most applications. For more information on designing the input filter and choosing proper values, contact SynQor technical support.

With the values listed above, the ripple current in L1 will be below 100mA RMS for all units. The full-load worst-case filter operation is summarized in Table 1.

Vout Model	Current (A RMS)	Ripple (V RMS)	Current in L1 (mA RMS)	Vp Ripple (V RMS)	Current in L1 (mA RMS)
0.9	5.2	0.06	32	0.04	21
1.0	5.5	0.07	34	0.04	22
1.2	6.0	0.08	40	0.05	27
1.5	6.7	0.09	47	0.06	31
1.8	7.4	0.11	54	0.07	36
2.0	7.8	0.11	59	0.08	39
2.5	8.8	0.13	69	0.09	46
3.3	10.4	0.15	81	0.10	54
5.0	12.3	0.16	86	0.11	57

Table 1: Full Load Input Filter Performance, SMA16

Adding significant external pure ceramic capacitance directly across the converter's input pins is not recommended. Parasitic inductance associated with the input pin geometry and PCB traces can create a high-Q CLC circuit with any external capacitors. Just a few nano-Henries of parasitic inductance can create a resonance (or an overtone) near the converter's switching frequency. C_{in} has a reactance of $10-20m\Omega$ at the 330kHz switching frequency. To avoid this high-frequency resonance, any external input filter should exhibit a net source impedance of at least $20m\Omega$ resistive through this frequency range. This requirement is easily met with the damping elements discussed above. Adding a small amount (a few μF) of high-frequency external ceramic will not violate it.

If using converters at higher powers, do consider the ripple current rating of C_d . Contact SynQor technical support for more

Technical Specification

Non-Isolated SMT Converter **9.6 - 14.4V_{in} 16A**

information.

Output Capacitance: It is recommended to add at least 100µF of capacitance, with an ESR in the 0.1Ω range, to the output of the SMA16 series of converters. The VMA16 series has this capacitance included internally. In many applications, however, additional external output capacitance is required to reduce the response to load transients to an allowable level.

The output impedance of these converters can be quite accurately modeled from DC to about 100kHz as shown in Figure D. A further simplified version of it, valid below 40Hz and above 1kHz, is shown in Figure E. In the SMA16 case, the models depict the minimum recommended output capacitance, C_t with its resistance R_t. In the VMA16 family, that capacitor is again included in the converter.

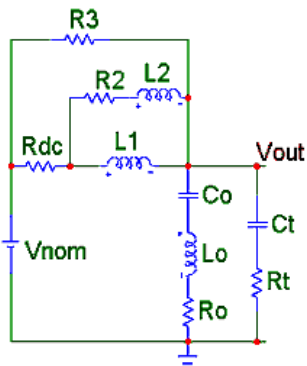

Figure D: NQ12 Passive Output Model

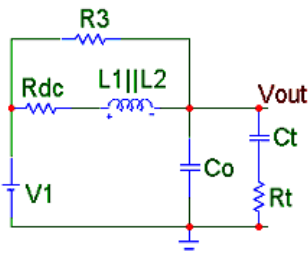

Figure E: Simplified NQ12 Output Model

If the dynamic characteristics of the load are known, any standard simulator can use these models to predict the in-circuit transient response.

If the transients are current steps then

Table 3 provides values for ESR_d and C_d for different allowable responses. The allowable step response is normalized to a 1A step, and the maximum allowable value of ESR_d can be read from the table.

Vnom	0.9	1.0	1.2	1.5	1.8	2.5	3.3	5.0
Rdc	360µΩ		490µΩ	450µΩ	365µΩ	300µΩ	330µΩ	510µΩ
L1	650nH		920nH	1.08µH	590nH	775nH	675nH	650nH
R2	4mΩ		4mΩ	4mΩ	2.0mΩ	3mΩ	2mΩ	1.5mΩ
L2	1.56µH		1.4µH	1.4µH	850nH	1.03µH	706nH	840nH
R3	29mΩ		31mΩ	32mΩ	35mΩ	30mΩ	29mΩ	35mΩ
Co	60µF		50µF	60µF	50µF	30µF	30µF	20µF
Lo	30nH		30nH	30nH	50nH	75nH	75nH	145nH
Ro	15mΩ		20mΩ	15mΩ	20mΩ	23mΩ	23mΩ	33mΩ
Ct	100µF	100µF	100µF	100µF	100µF	100µF	100µF	100µF
Rt	0.1Ω	0.1Ω	0.1Ω	0.1Ω	0.1Ω	0.1Ω	0.1Ω	0.1Ω

Table 2: Component Values for Passive Output Models

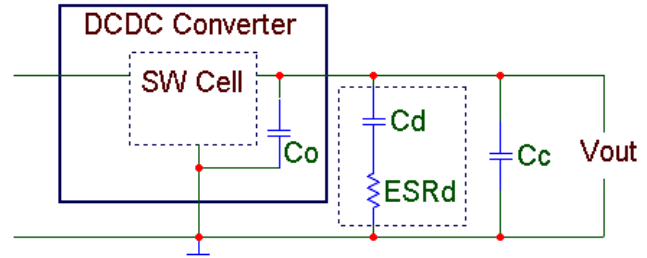

Figure F: Converter with Additional Output Capacitance

For minimal overshoot upon recovery, C_d should be related to the minimum in-circuit net ESR.

$$C_d > \frac{\text{parallel}(L1, L2)}{ESR_{d\min}^2}$$

The third column in Table 3 gives C_{dmin} for a 40% reduction in ESR and the highest L1 || L2 value in Table 2. For more detailed derivations of these values, contact SynQor technical support.

Load Current Step Response Pk mV/Amp	External Capacitor	
	ESR _d max	C _d min (µF)
23	0.1*	100*
19	0.05	400
14	0.025	1,600
9	0.0125	6,400
5	0.00625	25,600

* Included in VMA, min recommended for SMA

Table 3: External Capacitor Values for Different Step Responses

Thermal Performance (SMA16): While it's impossible to be exact, a simplified thermal model for the mounted converter is detailed below.

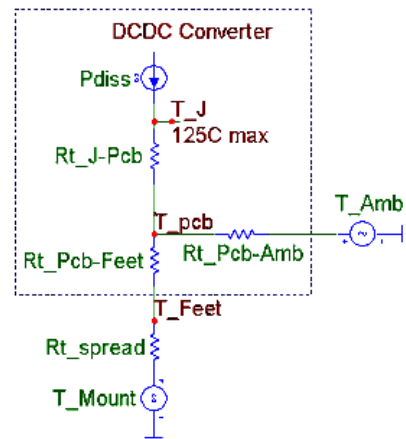

Figure G: Thermal Model for NQ12 Surface Mount

- Rt_{J-Pcb} models the conduction of heat from the converter's

hottest junction to the converter's PCB at large. It is about 3°C/W for converters running at higher output voltage, and about 4°C/W for lower voltage converters.

- **Rt_Pcb-Amb** models the power dissipation from converter PCB to the air stream. It ranges from about 15°C/W at 400LFM to about 25°C/W 100LFM.
- **Rt_Pcb-Feet** expresses the thermal path from the converter's PCB through its mounting feet; it is about 3°C/W.
- **Rt_spread** models the heat spreading on the PCB to which the converter is mounted and is largely dependent upon the construction and layout of that PCB.
- **T_mount** is the temperature of that PCB in the greater vicinity of the converter.

As is evident, the values for **Rt_spread** and **T_mount** will have great effect upon the thermal operation of the converter. With **Rt_Pcb-Amb** being 5 to 8 times as large as **Rt_Pcb-Feet**, in most applications these converters will be predominantly cooled via thermal conduction through their feet. Airflow and **T_Amb** will have only a minimal cooling effect.

- **Rt_spread** should be minimized. Attach the converter to large copper planes, on multiple layers, with multiple vias near the mounting feet.
- **T_mount** should also be minimized. Place the converter far enough away from other sources of heat on the PCB so that it is as cool as practical.
- If operation near derating limits is even suspected, thermal performance should be verified with the unit mounted in its intended manner and powered in circuit with all neighboring circuitry active. Attach a thermocouple to the converter's hotspot as shown in Figures 6, 8, and 10 in the Performance Curves section.

pads. Solder mask should be used to eliminate solder wicking into the vias.

Pick and Place: The **NiQor** surface mount modules are designed for automated assembly using standard SMT pick and place equipment. The modules have a centrally located inductor component with a flat surface area to be used for component pick-up. The units use open frame construction and have a low mass that is within the capability of standard pick and place equipment. Those modules however have a larger mass than most conventional SMT components and so variables such as nozzle size, tip style, handling speed, and placement pressure should be optimized for best results. A conformal tipped placement nozzle design is recommended. Coplanarity of better than 0.004" (0.1mm) is achieved through the SMT **NiQor**'s terminal design.

Reflow Soldering Guidelines: Figure H shows a typical reflow profile for a eutectic solder process. Due to variations in customer applications, materials and processes, it is not feasible for SynQor to recommend a specific reflow profile. The customer should use this profile as a guideline only. Since the **NiQor** surface mount modules have a larger thermal mass and lower thermal resistance than standard SMT components, it may be necessary to optimize the solder reflow profile based on limitations of the other components on the customer board. Sufficient reflow time must be allowed to fuse the plating on the connection to ensure a reliable solder joint. The solder reflow profile should be confirmed by accurately measuring the SMT interconnect leads. The guidelines illustrated in figure H must be observed to ensure the maximum case temperature of 260°C (exposure for 5 seconds or less) is not exceeded for the **NiQor** units.

SURFACE MOUNT INFORMATION

PCB Layout Considerations: SynQor recommends that the customer use a non-solder mask defined pad design. The minimum recommended pad size is 0.074" x 0.122" (1.88mm x 3.1mm) and the maximum pad size is 0.095" x 0.140" (2.41mm x 3.56mm), see mechanical diagram on page 2. Interconnection to internal power planes is typically required. This can be accomplished by placing a number of vias between the SMT pad and the relevant plane. The number and location of the vias should be determined based on electrical resistance, current and thermal requirements. "Via-in-pad" design should be avoided in the SMT

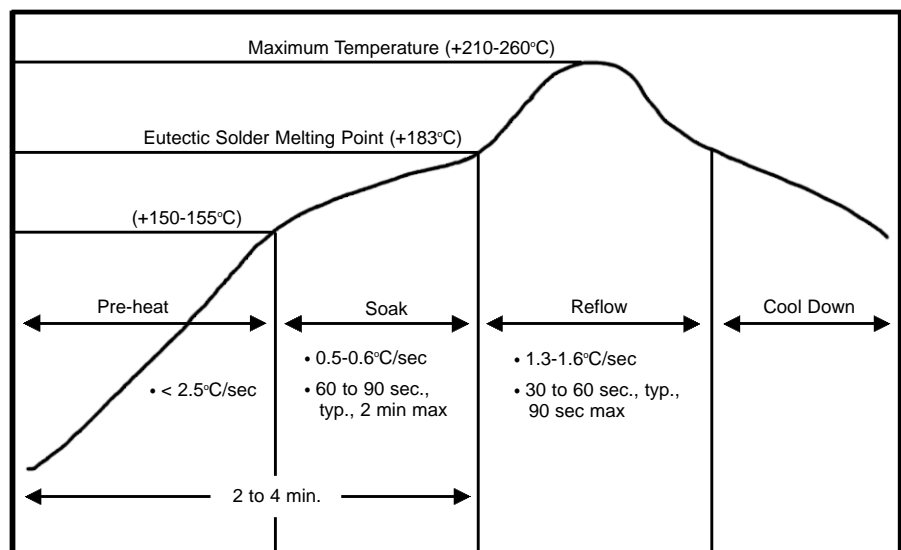

Figure H: Typical Eutectic (96.5Sn/3.0Ag/0.5Cu) Solder Profile

Lead-Free Soldering: The NiQor surface mount modules are manufactured with lead free solder and PCB finish and meet the conditions for Lead-Free 2 status. Users who wish to assemble the modules in a Lead Free solder process may require peak reflow temperatures exceeding 240°C. The maximum allowable case temperature of the surface mount NiQor modules is 260°C for no greater than 5 seconds.

Moisture Sensitivity: The NiQor surface mount modules have an MSL rating 1 per IPC/JEDEC J-STD-033A.

Cleaning and Drying: When possible, a no-clean solder paste system should be used to solder the NiQor SMT units to their application board. The modules are suitable for aqueous washing, however, the user must ensure sufficient drying to remove all water from the converter before powering up. Inadequate cleaning and drying can affect the reliability of the converter and the testing of the final assembly.

Tape & Reel Packaging: The NiQor SMT modules are supplied in tape and reel packaging in quantities of 320 units per reel. Packaging conforms to EIA-481 standards. Tape and reel dimensions are shown in the diagram below.

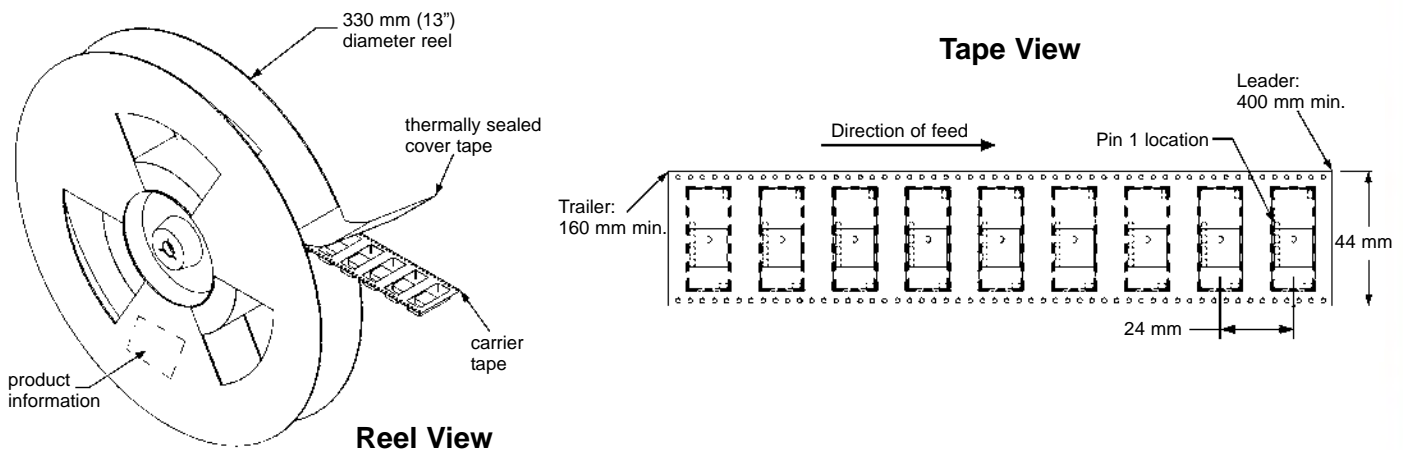

Technical Specification

**Non-Isolated
SMT Converter** **9.6 - 14.4V_{in} 16A**

PART NUMBERING SYSTEM

The part numbering system for SynQor's NiQor DC/DC converters follows the format shown in the example below.

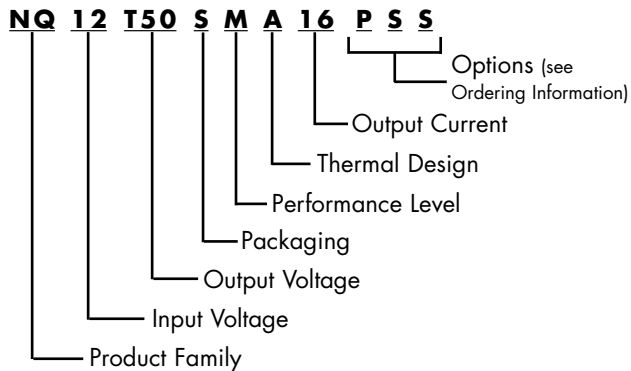

The first 12 characters comprise the base part number and the last 3 characters indicate available options.

Application Notes

A variety of application notes and technical white papers can be downloaded in pdf format at www.synqor.com.

ORDERING INFORMATION

The tables below show the valid model numbers and ordering options for converters in this product family. When ordering SynQor converters, please ensure that you use the complete 15 character part number consisting of the 12 character base part number and the additional 3 characters for options.

Model Number	Input Voltage	Output Voltage	Max Output Current
NQ12009SMA16xyz	9.6 - 14.4 V	0.9 V	16 A
NQ12010SMA16xyz	9.6 - 14.4 V	1.0 V	16 A
NQ12012SMA16xyz	9.6 - 14.4 V	1.2 V	16 A
NQ12015SMA16xyz	9.6 - 14.4 V	1.5 V	16 A
NQ12018SMA16xyz	9.6 - 14.4 V	1.8 V	16 A
NQ12020SMA16xyz	9.6 - 14.4 V	2.0 V	16 A
NQ12025SMA16xyz	9.6 - 14.4 V	2.5 V	16 A
NQ12033SMA16xyz	9.6 - 14.4 V	3.3 V	16 A
NQ12050SMA16xyz	9.6 - 14.4 V	5.0 V	16 A
NQ12T50SMA16xyz*	9.6 - 14.4 V	0.9-5.0 V	16 A

* Represents the wide trim unit. Detailed specifications for fixed output voltage modules are located in a separate datasheet located on the SynQor website.

The following option choices must be included in place of the x y z spaces in the model numbers listed above.

Options Description: x y z		
Enable Logic	Pin Style	Feature Set
P - Positive/Open	S - SMT	S - Standard

Contact SynQor for further information:

Phone: 978-849-0600
Toll Free: 888-567-9596
Fax: 978-849-0602
E-mail: sales@synqor.com
Web: www.synqor.com
Address: 155 Swanson Road
 Boxborough, MA 01719

Warranty

SynQor offers a three (3) year limited warranty. Complete warranty information is listed on our web site or is available upon request from SynQor.

Information furnished by SynQor is believed to be accurate and reliable. However, no responsibility is assumed by SynQor for its use, nor for any infringements of patents or other rights of third parties which may result from its use. No license is granted by implication or otherwise under any patent or patent rights of SynQor.